

CHAMPION™

Quality Healthcare Seating Products

Concord Series

MEDICAL RECLINER

RATED UP TO 275 LBS.

Part #220 MANUAL RECLINER



ARMS
OPEN
180°

Shown with optional cupholder.



Swing-away arms make transferring easier.



The trendelenburg position is a standard feature, as well as an all steel, powder-coated frame for durability.

STANDARD FEATURES

Swing-away arms

Trendelenburg

Three-position recliner

Fold-away side table (one)

Push handle

3" thermoplastic casters

The Concord treatment recliner features a user-friendly, push-back reclining mechanism, allowing patients to easily adjust to three positions. Trendelenburg comes standard with a convenient foot-release actuator on both sides. With many standard features, the Concord also offers a great value in a versatile recliner. The Concord is ideal for use in oncology, surgery centers, dialysis, infusion therapies, patient rooms and other treatment needs.

Foot-release trendelenburg



Push handle



Front-locking casters



STANDARD VINYL SELECTION



Natural
T09



Aquamarine
T19



Bonnie Blue
T21

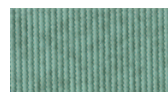

Iced Mint
T26

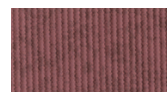

Tearose
T43



Colonial Blue
T45



Gray
T56

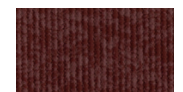

Cranberry
T96

Printed color swatches may not be an exact match to actual fabrics and are enlarged to show detail.

SPACE REQUIREMENTS

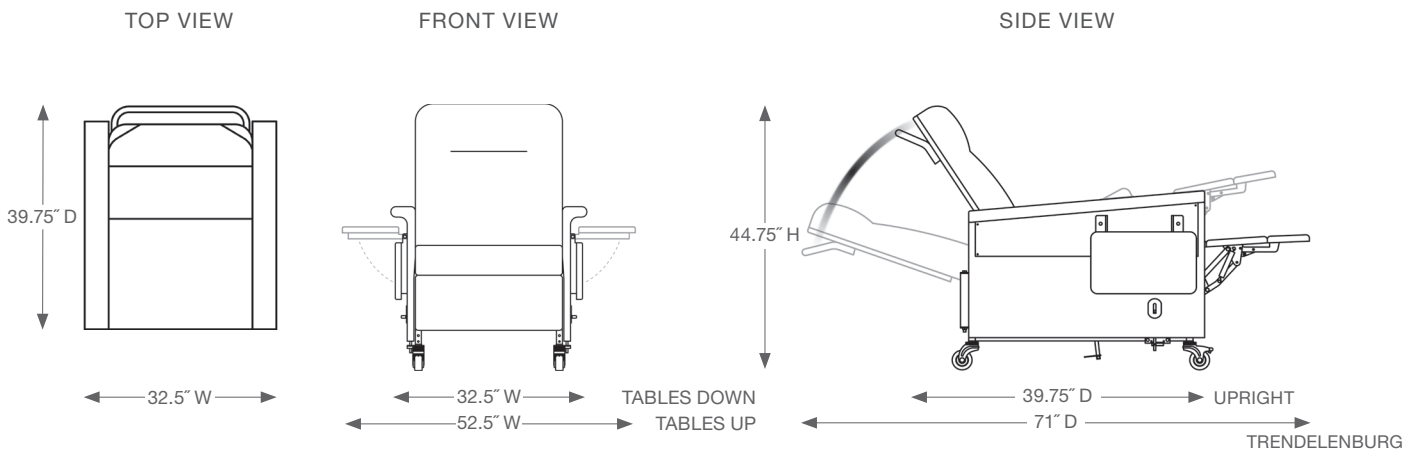

SPECIFICATIONS

| | |
|-------------------------------------|---------------|
| Weight capacity | 275 lbs. |
| Back height (from floor/seat) | 44.75"/27.75" |
| Overall width (2 tables down/up) | 32.5"/52.5" |
| Seat width | 24.75" |
| Arm height (from floor, front/back) | 27.5"/24.375" |
| Seat height/depth | 21"/19" |
| Upright overall depth (w/handle) | 39.75" |
| Trendelenburg depth | 71" |
| Thermoplastic casters | 3" |

TOP VIEW WITH SWING-AWAY ARMS

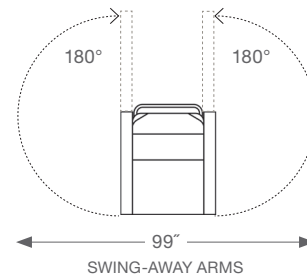

OPTIONS

Additional fold-away side table (S7)

Cupholder – on all tables (C), on one of two tables, specify (CUP-HOLDER L) or (CUP-HOLDER R)

CAL 133 fire barrier (3)*

Vinyl upgrades

Champion, non-standard vinyl (NSV)**

Customer's own material (COM)

PVC-free material

Antimicrobial material

* Contact Champion for a list of fire-tested vinyls.

**For available patterns and colors for non-standard vinyl, please contact your Champion sales representative.

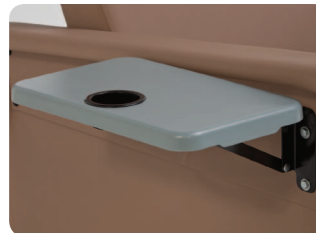

CUPHOLDER

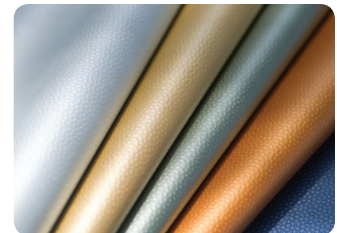

VINYL UPGRADES

ACCESSORIES

Provide your patient the best care and comfort with cupholders, head pillow/lumbar support, cushion wedge, arm covers, LED reading light, IV pole/bracket or an oxygen tank holder. For a complete list of our

accessories, please see our *Accessories* brochure or ask your Champion sales representative for more information.

CHAMPION™

Champion Manufacturing, Inc.
2601 Industrial Parkway, Elkhart, IN 46516

1.800.998.5018
www.championchair.com